



english

November 2006

**The latest release of this manual can be downloaded from our website (pdf-file).**

schlumpf innovations gmbh  
Dorfstr. 10  
CH - 7324 Vilters/Switzerland  
Tel: +41 (0)81 723 80 09  
Fax: +41 (0)81 723 83 64  
email: info@schlumpf.ch  
**www.schlumpf.ch**  
**www.mountain-drive.com**  
Geschäftsführer:  
Florian Schlumpf Masch.Ing.HTL



## Content

|  |     |
|--|-----|
| <b>Where can <i>mountain-drive</i> be installed?</b> | A-1 |
| - Standard frames                                    |     |
| - Large-diameter bottom brackets                     |     |
| - Frames without a standard chainstay                |     |
| - Replacing a triple chainring                       | A-2 |
| - Double chainrings                                  |     |
| - Triple chainrings                                  | A-3 |
| - Extra wide bottom brackets (wider than 74mm)       | A-4 |
| - Brompton   |     |
| - Birdy  | A-5 |
| - Dahon  |     |
| - Moulton  |     |
| - Frog   |     |
| - Left-hand installation                             | A-6 |
| - Fixed-gear bikes                                   |     |
| - Single-speed                                       |     |
| - Tandems  |     |
| - Closed chainguards                                 |     |
| - Chainguard holder                                  |     |
| - Special applications                               | A-7 |
| - Handbikes  |     |
| - Special versions for handbikes                     |     |
| <b>Installation</b>                                  | B-1 |
| - Standard torque lever                              |     |
| - Screwed-on torque lever                            |     |
| - Custom torque-lever attachments                    |     |
| - Spezial clamps                                     |     |
| - Shims  |     |
| - Adapters for larger bottom bracket diameters       | B-2 |
| - Chamfering the bottom bracket                      |     |
| - Cone rings for aluminum and steel frames           |     |
| - Extra wide cone rings                              |     |
| - Tightening   |     |
| - Chainrings   | B-3 |
| - Trouser guards                                     |     |
| - Chainring screw sets                               | B-4 |
| - Mass assembly of chainrings                        |     |
| - Axle bolts   | B-5 |
| - Gear shift buttons                                 |     |



- New gear shift buttons B-6
- Mass assembly of gear shift buttons

---

**Maintenance** C-1

- Lubrication
- Adjusting the gearing play
- Swapping chainrings C-2
- Removing cranks

---

**FAQ** D-1

---

**Accessories** E-1

---

**Trouble-shooting** F-1

---

**Disassembly and assembly** G-1

- Disassembly of gear shift button and crankarm
- Dismounting
- Assembly

---

**Installation instructions** H-1

---

**Rollout / development** I-1

---

**Technical data** J-1

---

**Cross section** K-1

---

**Check list before ordering** L-1

---

## Where can *mountain-drive* be installed?

### Standard frames

#### Frames with BSA bottom brackets (inner diameter of 33.6 - 34mm)

Insert the *mountain-drive* unit with torque lever in the empty bottom bracket shell. If necessary, use shims (1/10mm thickness, included in the shipment) to make up for small difference in diameter.

Please check to make sure that the bottom bracket faces are perfectly flat and square. If necessary, mill them with a 90-degree bottom bracket miller.

The torque lever is attached to the chainstay with a clamp.

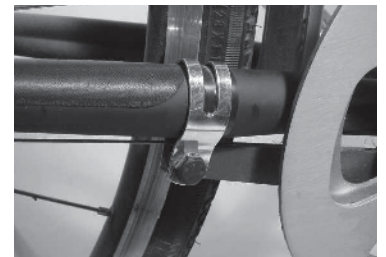

#### Large-diameter bottom brackets (larger than 34mm, as in Thompson and Fauber bottom brackets)

Use a pair of adapters for larger diameters. The torque lever version of *mountain-drive* can be installed on bottom brackets of any diameter.

Please give us the inner diameter of the bottom bracket shell when ordering adapters.

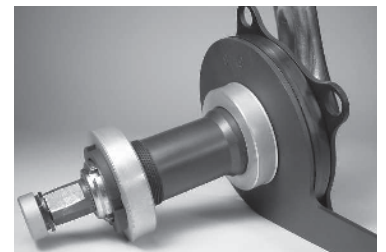

#### Frames without a standard chainstay (for example recumbents, folding bicycles, bikes with rear suspension)

To fit the *mountain-drive* unit without the torque lever, you must chamfer the bottom bracket with a milling cutter.

The tool is available as an accessory or on a rental basis ( we have a tool-rental service in most countries).

The cone option requires that you follow our instructions carefully for good results.

Chamfering and tensioning must be performed very precisely.

With the cone rings, you must not clamp any parts (trouser guard, chain holders, etc.) between gear housing and cone ring.





**Important:** On the right-hand side, always use a steel cone ring for aluminum bottom brackets and an aluminum cone ring for steel bottom brackets!

Tighten with the box spanner (-> tool set "Installation + Maintenance") to a tension of 140 - 160Nm (100 - 115 lbf).



## Replacing a triple chainring

Frames made for triple chainrings often do not have room for a **mountain-drive** installation.

Please make sure that there is enough space for the chainring of your choice at the middle chainring's position.

It is important to position the **mountain-drives** chainring to match the middle chainring on a triple. Mounting outside of that position will cause chainline problems, and you could drop the chain in low gears.

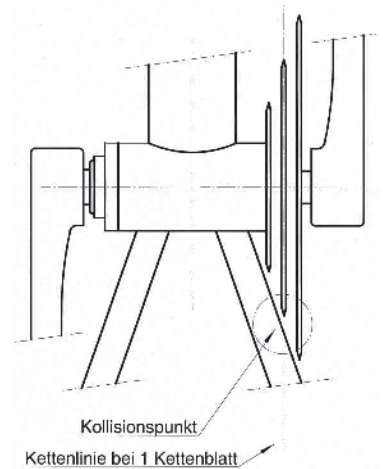

## Double chainrings

Bikes built for double chainrings can easily accommodate any **mountain-drive**.

For heavy-duty applications, please use the steel spider, which takes 8 screws.

One chainring is fitted to the right side of the spider, one to the left. Always use a 2mm spacer between.

Steel spiders are available with bolt circle diameters (BCD) of 110 and 130mm.



## Triple chainrings

It is possible to mount three chainrings on a **mountain-drive**, if required. Always use the steel spider! Available in BCD 110 and 130mm.





## Extra-wide bottom brackets / Rohloff Speedhub

The standard **mountain-drive** is designed for bottom bracket widths of 67.5-73mm.

For special bottom brackets wider than 73mm, we offer a version with an axle 10mm longer.

When ordering the version for wide bottom brackets, please mention your bottom bracket's exact width so that we can include a pair of spacers as needed. This "+10mm" version is also used for "Long John" transportation bikes and certain Moulton and Birdy folding bikes (see next page).

It is also recommended for a combination with **Rohloff Speedhub**. With spacer tubes, the wide chainline required for Rohloff can easily be achieved. Please note, that Rohloff only recommends to combine its Speedhub with **Schlumpf speed-drive**, due to a minimal chainring size required.



## Brompton

The Brompton version comes with a 6.5mm spacer to allow folding the bike.

The chainline remains unchanged, as we use special spacers for this application.

The Brompton bicycle has an extremely thin-walled bottom bracket shell. We therefore use a special torque lever to limit the counter-force.

You can either chamfer the bottom bracket and use cone rings for perfectly centering the unit or use shims for making up for small differences in the bottom bracket inner diameter.

The Brompton version also comes with a modified nut on the left side for tightening.

For keeping the chainline at its original position, the chainring is mounted with three spacers of 2mm thickness each. If using a trouser guard, there are two spacers (one on each side of the trouser guard).

Chainrings with bolt circle diameters of 110mm for Brompton folding bikes must be turned on a lathe to enlarge the inside diameter from 94 to approximately 96mm. Larger chainrings with 54 or 56 teeth (BCD 130mm) don't need to be milled).

Please note: Original **mountain-drive** chainrings just come with the appropriate inside diameter.

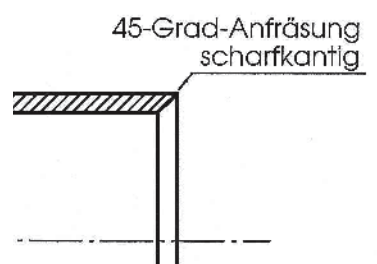

## Birdy

The Birdy with its thick-walled bottom bracket shell made of aluminum, always allows for the cone-ring installation. No torque lever is required.

Please note: Birdy models prior to 1999 had an unusually wide chainline of 56 mm. For them, we can deliver the longer axle with spacers.

Newer Birdies have a chainline of approximately 50 mm. Here, you screw the chainring to the outer side of the spider to get the correct chainline.

If using a chainring larger than 50 teeth and fitting it to the outside, please use the steel spider.

The Birdy **mountain-drive** always requires two trouser guards to hold the chain when being folded.

The **speed-drive** is often the better choice for the Birdy, as this type is very compact and offers even higher gears.



## Dahon

Newer Dahon models no longer have a seat tube that penetrates the bottom bracket. A standard **mountain-drive** will now fit without problems.

If your Dahon comes with a chainguard, use the torque lever version, and clamp it with a holder between bottom bracket and shell.



## Moulton

For all Moulton bikes, **speed-drive** may be the better solution due to the small rear wheel.

**Please note:** Many Moultons have a screw on the right side, that protrudes from the bottom bracket. Others have a part of the rear suspension, that interferes with the **mountain-drive/speed-drive** housing. The outer diameter of the **mountain-drive/speed-drive** housing is approximately 95mm. If there is no room for the housing, please order the "+10mm" longer axle. We will deliver spacers to place the gear housing farther to the right.

Please note: The bottom bracket shells of Moulton bikes are extremely thin-walled. Only if following our instructions carefully (chamfering and tensioning must be performed very precisely), you can expect good results!

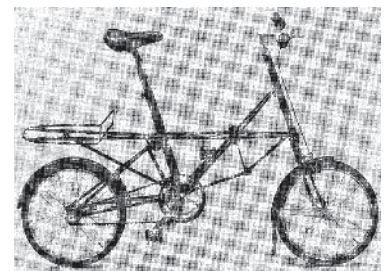

## Frog

We recommend to use **speed-drive** for the R&M Frog. With a small chainring, you get high speed, that can't be achieved with the standard set-up.

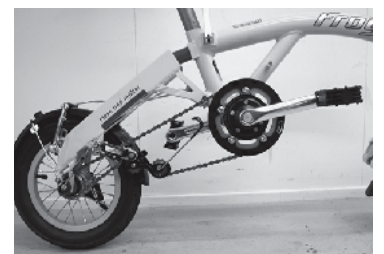

## Left-hand installation

The **mountain-drive's** clutch is only designed to operate in one direction (clockwise, with the chainring on the right side). For a left-hand installation, please use the mirror-image version.



## Fixed-gear bikes

The **mountain-drive** mechanism is not designed to withstand high-torque pedaling in both directions.

## Single-speed

The **speed-drive** is a more appropriate solution for single speed bikes, as the step of 1 : 2.5 of the **mountain-drive** may be too big with no other gearing system for smaller steps!



## Tandems

**mountain-drive** can be used on tandems. Please note, that **mountain-drive** greatly increases the torque exerted on the rear gearing system. Combined with the torque generated by two riders, it can overload the rear gearing system.

The **mountain-drive** system is installed at the stoker's position. You can use the original left crankarm with spider and chainring for the left side. If using crankarms that are not stock, please check, that the hole, where the gear shift button is located, has a depth of at least 8mm (to ensure that the gear shift button doesn't protrude when pushed in).

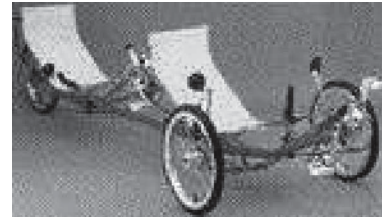

## Closed chainguard

If you want to use a closed chainguard with a **mountain-drive** with torque lever, you'd have to cut a hole into the back side of the chainguard for the torque lever.

You better use the version with cone rings. Please consider, that you mustn't clamp a chainguard holder or other items between **mountain-drive** housing and bottom bracket shell!

## Clamped chainguard holder

Please note, that for all **mountain-drives**, that come without torque lever, there mustn't be any parts clamped between bottom bracket shell and gear housing.

Any such holder can only be used for the **mountain-drive** version with torque lever.







A-6

## Special versions

We offer custom versions of all of our gearing systems for special applications such as the back pack airplane "Flyke" on the right! This one for example comes with an extra wide bottom bracket shell (needed for landing!).

Ask us for an offer.



## Handbikes

Nearly all handbike makers offer their handbikes with **mountain-drive**. We make many special versions, for example such with longer axles.

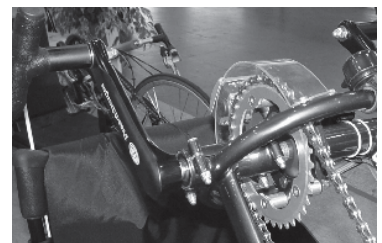

## Installation

### How to fit the standard torque lever

Most "standard" bikes without rear suspension have a chainstay, where you can fit the torque lever and its clamp (the clamp is included in the shipment).

You can slightly bend the torque lever if required, up to a distance of about 10mm.

To prevent the housing from being damaged, please tighten the nut on the left side first before bending the lever.

Platzbedarf

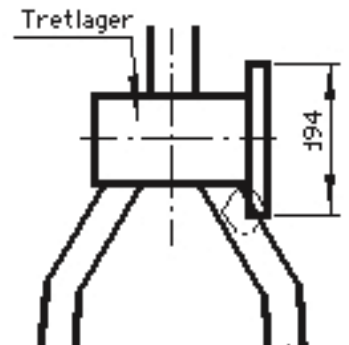

### Screwed-on torque lever

For special purposes, we can deliver the housing with a screwed-on torque lever. You can detach it and hold the screw through the lubrication hole, when tightening.

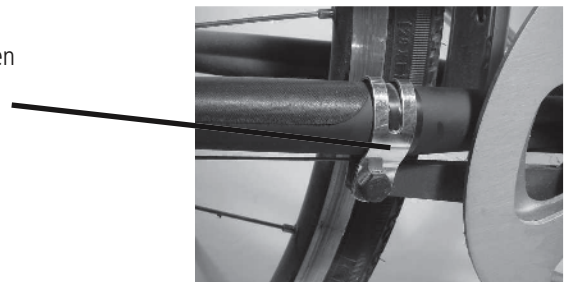

### Custom torque-lever attachments

To attach the torque lever directly to a brazed or welded tang on your frame, please refer to the drawing to the right.

The torque lever takes an M6 screw.

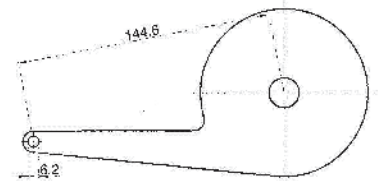

### Special clamps

Bikes requiring a special attachment, such as the central tube of a recumbent, may need special clamps. Refer to the drawing to the right for the clamp's required dimensions..



### Shims

For a torque-lever installation, use shims as needed to radially center the unit in the bottom bracket shell (maximal inner diameter of bottom bracket shell: 34.0mm). For larger inner diameters, please use adapters (see below).



### Adapters for larger bottom-bracket diameter

The *mountain-drive* with torque lever can be installed into a bottom bracket of any diameter by using a pair of adapters. Please specify the inner diameter of the bottom bracket shell when ordering.



### Chamfering the bottom bracket

To install cones, you must mill a 45° bevel into both of the bottom bracket's faces. The outer diameter of this conical part must be between 39 and 39.5mm. This is very important, as it creates additional surface area, so that the cone rings will have enough friction to counter the torque of the planetary system.



Do not chamfer up to an outer diameter of 40mm, as this will allow the cone rings to "swim" within the chamfered part with no load on their surface, even with correct tightening

Use some cutting oil for lubrication while chamfering.  
For installation, the conical areas must be completely dry and clean! No grease!

Please note: In most countries, the 45° milling cutter can also be rented.



### Cone rings for aluminum and steel frames

Use a knurled steel cone for aluminum frames and an aluminum cone for steel frames.

Please mention your frame's material when ordering.

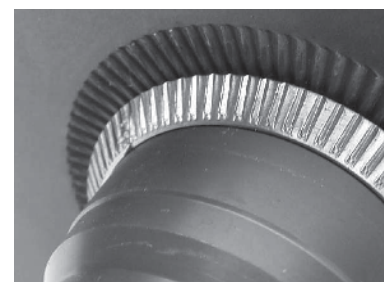
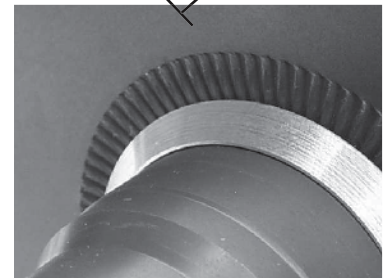

### Cone rings with additional width

For special applications, we offer cone rings with additional 2, 4 or 6mm of width.

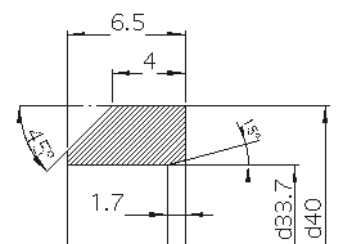

## Tightening

The (black) **mountain-drive** nut on the left side must be tightened to the correct torque for correct operation.

If available, always use a torque wrench for tightening (torque on cone rings: 140-160 Nm / 100-115 lb ft).

**Important:** The **mountain-drive** nut has a left hand thread!!

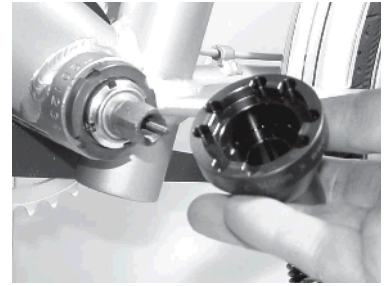

## Chainrings

As far as possible, the chainring should be fitted to the left side of the spider. If fitting a chainring to the right side of the spider, high torques make the optional steel spider (with eight screws) a necessity.

Note: Original Schlumpf chainrings can be mounted with the **mountain-drive** unit already installed in the frame.

**Chainrings smaller than 40teeth** must have an inner diameter of 96mm (instead of 94) in order to pass over the spider.

If your bike needs a different chainline (distance from centerline of frame to centerline of chain), you can use longer chainring screw sets combined with spacers. Please contact us..

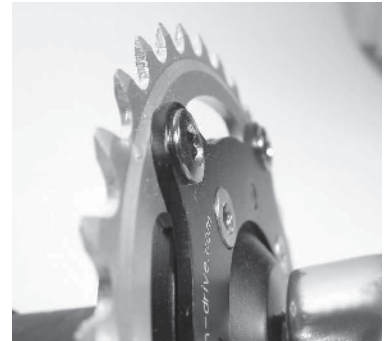

## Trouser guards

If mounting trouser guards, always use a 2mm spacer between chainring and spider or between spider and trouser guard, according to the chainline you want to achieve.

Two trouser guards can easily be fitted by mounting one on the left side of the chainring (with two 2mm spacers between) and one to the right side of the spider. (with one 2mm spacer between).

**mountain-drive** for the Brompton folding bicycle comes with a 6mm spacer to allow the bike to be folded. The chainring is fitted with either 3 x 2mm spacers (no trouser guard) or with 2 x 2mm spacers plus trouser guard to keep chainline in its original position.



## Chaining screw sets

When using your own chaining screws and nuts, make sure they have the correct length.

The nut mustn't be flush with the surface of the spider (see photo on the right side) so that the screw can be properly tightened. If the screw does not have at least 0.5mm of margin, the nut will spin and cannot be tightened correctly.

If the nut seems to be too long, you can turn the chaining around.

For easy tightening, put a very small amount of grease on the thread of the screw.

Tighten the screw very well. If it continues spinning, check the nut's length (see above). Try turning the chaining around.

If the length is correct, the screw can be tightened easily without holding the nut.

If the chaining screws aren't tightened enough, they will quickly damage spider and chaining.

**Never use thread-locking compounds (Loctite, etc.)!**

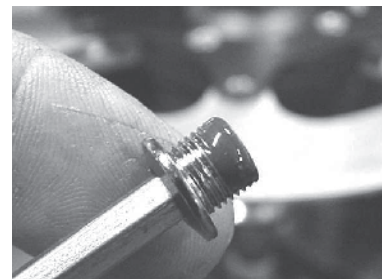
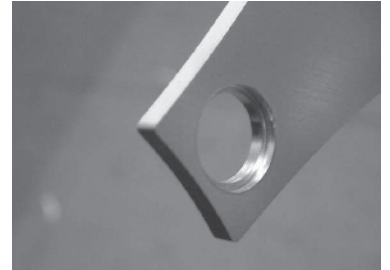
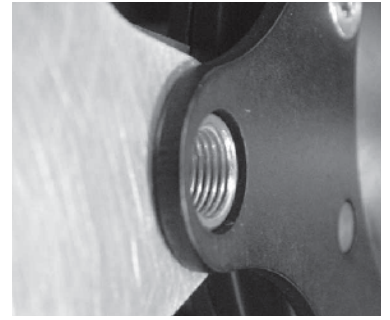

## Mass assembly of chainrings

If you are fitting a large number of chainrings, the following device makes it easy:

Take a chaining with the bolt circle diameter of the chainrings, that you have to fit.

Mill out the inner diameter by about 2mm.

Affix the chaining to the edge of your workbench (drill a hole near the outer diameter and use a countersunk screw).

Place the 5 nuts of the chaining screw set, add chaining, spacers, trouser guards and all parts, that you want to fit, and finally the screw (with a small amount of grease).

For tightening the screws, fit a crankarm to the workbench or hold it in a vise, and put the **mountain-drive** on top of the crank for final tightening.

Please note: if the length of the nut is correct (not flush with the spider), screws will never spin while being tightened!

**Never use thread-locking compounds on chaining screw sets!!**

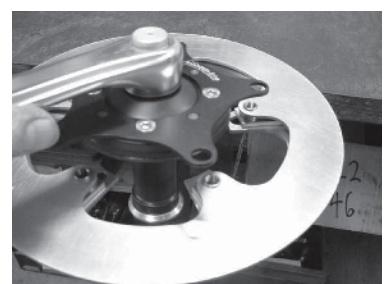



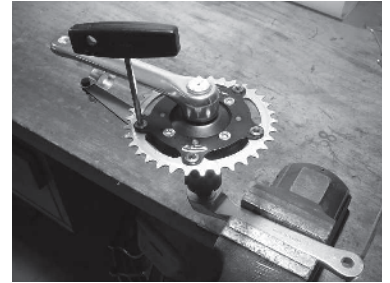

## Axle bolts

Apply some grease to the thread of the axle bolt, but not to the spindle end. Use a 14mm box wrench and tighten the nut with 50-55Nm (40 lb ft).

**Axle bolts, that haven't been tightened with the appropriate torque, can come loose and damage the thin shifting shaft and gear-shift button!**

## Gear-shift button

One of the most important adjustments is the correct positioning of the gear shift button.

Please spend a few moments reading this to understand why this is so important:

- If a **gear shift push button** is screwed on too much, the clutch, which has to transmit the high torques from the axle to the sunwheel or planet carrier, can't engage correctly. The load on the teeth of the clutch increases and the clutch can be damaged by excessive pressure.

It is most important, that there is still some inward play on the button, even when it is in its depressed position! It isn't important how much travel the button still has.

If using our original crankarms, the position of the button is correct, when the push button is flush with the surface of the crank.

If **using your own crankarms**, please check the cranks before of assembling them. Hold the crankarm in your hand and put an axle bolt and gear-shift button in the hole of the crank. Now you can see, whether the button is too high. Its surface should be below the surface of the crankarm.

- The gear shift button must be tightened with a torque of 110 cNm. It may be difficult to find such a low-torque torque wrench. That's why we include a high-quality 1.5 mm hex bit in the tool sets for tightening the gear shift button.

Hold the gear-shift button with a pair of pliers (old model) or the special wrench (for new, round buttons shipped later than October 2004) while tightening very firmly.

Finally attempt to unscrew them by hand. If you can, you will lose the button soon. Tighten it again!

Never use thread-locking compounds. If the button is tightened correctly, you'll never lose it.



## New gear shift buttons (since October 2004)

The new designed gear shift buttons allow easier tightening.

The button must be approximately flush with the surface of the crank, when being pushed. It can protrude up to 1mm (especially in combination with easy-shift kick plates).

Then tighten the small Allen screw M3x5 within the button by holding the button with the special wrench, that comes with every tool set.

Use a 1.5mm Allen wrench or the 1.5mm bit of our tool sets.

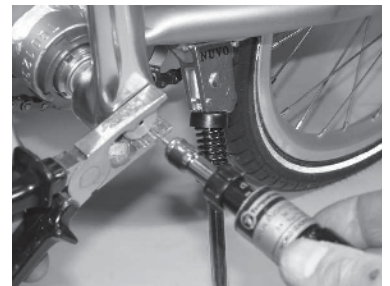

## Mass installation of gear shift buttons

If you will regularly be installing our gearing systems, we recommend using a torque wrench, that can measure a torque of 110cNm.

A torque screw driver is available as accessory.



## Maintenance

### Lubrication

An O-ring at the outer diameter protects the **mountain-drive** against dust and spray. The O-ring exerts only a limited pressure to minimize friction losses, and therefore cannot retain an oil-bath.

The original lubrication is done with a low temperature grease, which is a good compromise between oil and grease lubrication characteristics, and is also an effective long-term lubrication in case, the rider never does any maintenance.

Syringes with 5ml are available as an accessory. They provide enough lubrication for at least 3'000-4'000 miles.

Oil lubrication also gives good results. Insert a few drops 1-2 times a year or after 2'000-3'000 miles. Too much oil can cause leakage.

If the **mountain-drive** starts running noisily in high gear (when there is no load on the planets), this is probably due to a lack of oil on the planet bearings. Insert some lube at the slot screw on the right side (on **mountain-drives** with steel spider and 8 screws you may have to remove one of the hex screws).

Grease and oil each have their benefits. Grease damps noise much more effectively than oil. Oil causes less friction losses, especially at low temperatures.

### Adjusting the gearing play

The axle has three cartridge bearings. Their life expectancy is at least 20,000-30,000 km. These are of standard size (6903 2RS) and commonly available.

The bearings for the planetary system are 3 ball races with balls of 4.00 mm diameter (not 5/32", which is a very similar size).

Please note: the adjustment of the gearing play is made at the factory with painstaking accuracy. Do not change the position of the self-locking nut at the left end of the axle without a good reason.

Only adjust the gearing play, if the chainring has play along the axis of the spindle. Slightly tighten up the self-locking nut on the left end of the axle (only a few degrees). Never tighten the nut too firmly. Preload on the gearing system may damage the bearings.

Please note, that some play between the cranks and chainring in the direction of rotation is normal and necessary for proper engagement of the gears after switching.

To check a potentially incorrect adjustment, proceed as follows:

- Unscrew the self-locking nut on the axle 1/4 - 1/2 turns.
- Move the chainring in the direction of the spindle to feel the play
- Slowly tighten the nut while moving the chainring at the same time.
- Feel the play decreasing.

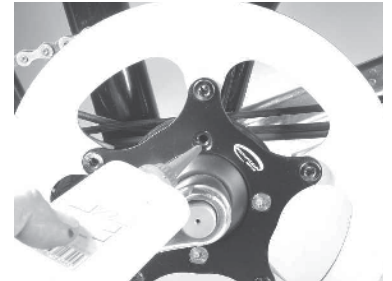
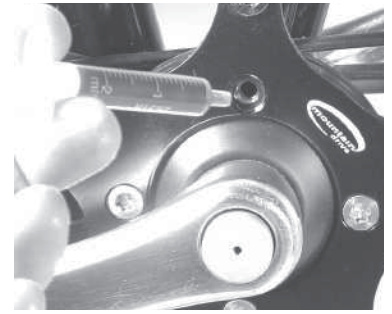

## Swapping chainrings

Please note, that 34, 36 and 38t. chainrings, that are not original **mountain-drive** spare parts have to be milled out at the inner diameter from 94 to 96mm. Otherwise, you will not be able to mount them on the left side of the spider without removing the whole gearing system!

With Brompton folding bikes, use only the original chainrings: they are also milled out to an inner diameter of 96mm for the following sizes: 34, 36, 38, 40, 42, 44, 46, 48, 50, 52, 53t. Larger ones (54, 56t.) have a different bolt circle (130mm) and don't need to be modified.

## Removing cranks

To remove a crank, proceed as follows:

- Hold the gear shift button with pliers (up to model year 2004) or with the special wrench (for new, rounded design) and unscrew the tiny Allen screw M3 with an 1.5-mm Allen wrench or 1.5mm hex bit (part of our tool sets).
- Unscrew the button.
- Remove the axle bolt with a 14mm box spanner. Check, to make sure that the washer underneath the bolt didn't remain in the axle hole.
- Insert the small tube (part of our tool sets) before using a standard puller to remove the crank. (an M6-nut may do the job as well, if you don't have the original tube).

**Very important:** If not using the small tube or an M6 nut, you will destroy the shifting shaft when pushing with a standard puller!

If using a different crankarm not provided by the manufacturer, make sure the hole has a depth of at least 8mm.

Please also make sure that the right-side crankarm is not wider than 25mm, to prevent it from touching the spider when being tightened.

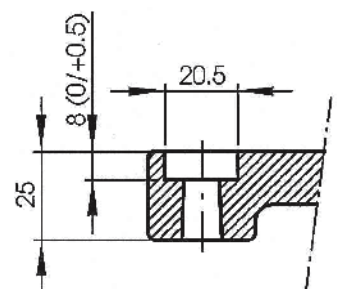

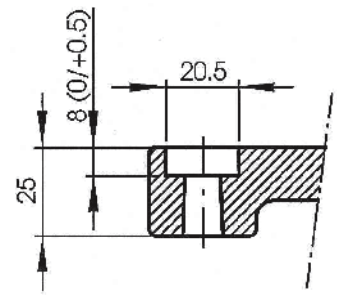

## FAQ

### Can I use any crankarms I want?

Theoretically yes.

Please consider that on the right side, the crank is not connected to a spider. It looks exactly like a left-hand crank, but has a right-hand thread for the pedal. You may take one from a tandem captain's cranks, which usually has the correct type of crankarm on the right.

Also make sure that there is enough space for the axle bolt and gear-shift button (depth of 8mm) and that the right crankarm is not wider than 25mm.

### Can I use any chainrings?

In principle yes.

Please note that 34, 36 and 38t. chainrings other than original **mountain-drive** parts must be milled out on the inside from 94 to 96mm. Otherwise, you will not be able to mount them on the left side of the spider without removing the whole gearing system!

With Brompton folding bikes, only use the original chainrings: they are also milled out to an inner diameter of 96mm for the following sizes: 34, 36, 38, 40, 42, 44, 46, 48, 50, 52, 53t. Larger ones (54, 56t.) have a different bolt circle (130mm) and don't need to be modified.

| Distanz x | Lochkreis |
|-----------|-----------|
| 64.5mm    | 110       |
| 71.5mm    | 122       |
| 76.5mm    | 130       |
| 79.5mm    | 135       |



### Can I combine **mountain-drive** with a coaster brake (back pedal brake)?

Yes, you can. Please consider, that in low gear, travel of the pedals to activate the coaster brake is 2.5 times longer than in direct drive 1:1. On the other hand, you need 2.5 times less force, so in reality, a coaster brake on a **mountain-drive** equipped bike works very well.

### What types of internal hubs can be used with **mountain-drive** ?

Theoretically, **mountain-drive** due to its 2.5x speed reduction creates a 2.5 times higher torque on the rear transmission.

This is just theory and is true only if you ascend a given gradient 2.5 times faster.

With other words: if your speed is the same at the same slope, **mountain-drive** reduces the force on your knees by increasing the number of revolutions of the pedals. The load on the rear component, either an internal hub or a derailleur, remains the same!

Load increases, if you use **mountain-drive** on a tandem, or if you add a trailer with heavy load. In this case, load on the rear component can exceed the value, which is guaranteed by the hub maker.

The past 12 years of combining **mountain-drive** with all systems such as Shimano Nexus 4-, 7- and 8-speed hubs, SRAM (former Sachs) 3-, 5-, 7-speed hubs and Sturmey-Archer hubs have shown, that these combinations work absolutely perfect.

For heavy duty applications, there are some products designed for tandems, like the SRAM 5-speed-hub "Cargo", which is equipped with milled planet gears instead of powder metal parts like in most other gearing systems. Other applications, especially user-installed ones, may work, but will not be covered by the hub manufacturer's warranty.



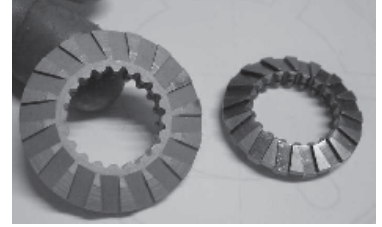

## Can *mountain-drive* be used on a rikshaw?

Yes, it can.

All our gearing systems come with the new 80% larger "Cargo" clutch, introduced in 2003. There is no part in the gearing system, that can brake even under harshest conditions, if only installation has been done according to our instructions.

There are several customers, who have done more than 50'000 km on a ***mountain-drive*** equipped bike. We could check some of those, and there was hardly any wear on any gearing parts visible.

If you have the choice for the rear hub, take the SRAM Cargo 5-speed-hub, which is designed for heavy load, and which gives an evenly spaced 10-speed gear range of not less than 560%!

## Accessories

### Adapter for internal hubs

We offer adapters, that allow to fit a BCD74 or BCD110mm chainring on a Shimano, SRAM or Sturmey Archer (SunRace) hub (Please note: the new SunRace 8-speed-hub uses a different flange pattern). This allows to get smaller gears without reducing the front chainring too much!

If you want to get very low speeds, it is better to increase the size of the rear cog than to reduce the size of the chainring. This reduces load on the parts and gives longer lifetime of all components.



### Chainrings and trouser guards

We offer nearly any chainring and trouser guard. All trouser guards are Swiss made and use high quality aluminum alloy.



### CNC milled chainrings

We also offer chainrings from 34 up to 75t. made of 7075 aluminum alloy, CNC milled. 7075 aluminum has a much higher strength than steel!

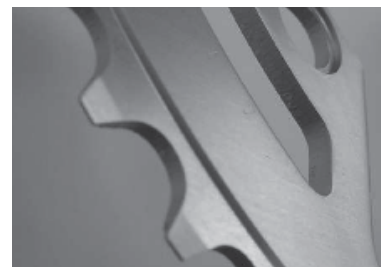

## Easy-shift kickplates

Easy shifting even with small shoes and/or klik in pedal systems.

The levers can be retrofitted. They are clamped between crankarm and pedal.  
The gear shift button remains the same.

Important: Easy-shift levers only fit straight 170mm crankarms.

### Installation:

- Put the lever to the outside of the crankarm.
- The washer with its concave side towards the crankarm!
- Tighten the pedal.

Please note: if the lever rattles when pedaling, unscrew the pedal again and slightly bend the lever towards the crankarm to give more tension.

**Brompton folding bike:** no washer at the folding pedal!

Finish: high polished or black anodized aluminum.

We offer levers with your own logo (starting at 10 pairs at no extra cost).  
Please ask us.



## Tool sets

### Tool set "Installation + Maintenance"

For easy installation, the box spanner is indispensable. It can be combined with a 1/2" ratchet or better with a 1/2" torque wrench.

Tightening torque for **mountain-drive** with torque lever is 80-100 Nm (60-75 lbf), for mountain-drive with cone rings 140-160Nm (100-115 lbf).

Please use the small tube for pulling off the crankarm with a standard puller. It avoids any damage to the thin shifting shaft!

A 1.5mm hex bit and a special wrench makes tightening of the gear shift button easy and safe.

Content of the tool set "Installation + Maintenance":

- box spanner 1/2"
- C-spanner for adjusting an eventual gearing play
- 1.5mm hex bit
- tube for pulling off crankarm with standard puller
- special wrench for tightening new designed gear shift buttons

### Tool set "Maintenance"

Same content except box spanner:

- C-spanner for adjusting an eventual gearing play
- 1.5mm hex bit
- tube for pulling off crankarm with standard puller
- special wrench for tightening new designed gear shift buttons

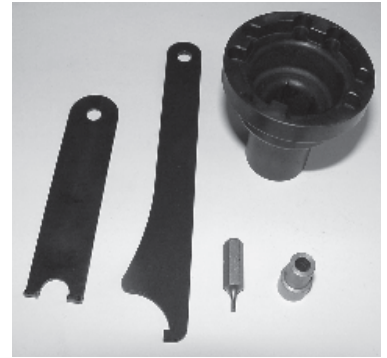

Tool set "Installation + Maintenance"

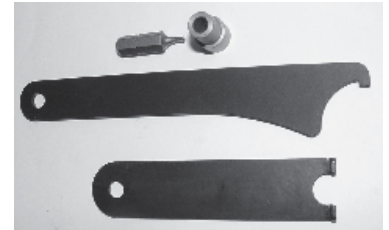

Tool set "Maintenance"



Tube for pulling off crankarm with standard puller



Spare gear shift buttons with tools

### Torque wrench for gear shift buttons

This tool is preadjusted to 1.1Nm (110cNm) and tightens gear shift button to the appropriate torque. You'll never lose a gear shift button!

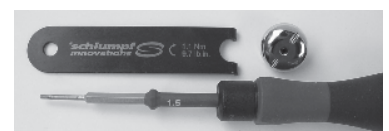

## Crankarms

### Standard crank 170mm, straight shape.

The standard crankarm is a cold forged, hand polished high quality crankarm.



Standard crankarm 170mm, straight shape

### Offset crankarms 102, 114, 127, 140, 152, 160, 165, 170, 172.5 and 175mm

Please note, that these crankarms, all with offset shape, cannot be combined with the easy-shift kickplates!

All crankarms are available either with high polished aluminum or black anodized finish.



89 - 175mm available



175mm crankarm, offset shape, black anodized

### Size of crankarm

If using another than an original **Schlumpf** crankarm, please first check width and depth of the hole and the total width of the crank!

The hole for the gear shift button should have a depth of at least 8mm, and the total width of the crank shouldn't much exceed 25mm.

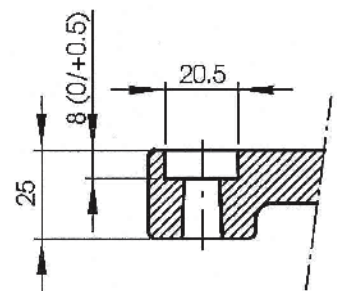

If using another than an original **Schlumpf** crankarm, please first check width and depth of the hole and the total width of the crank!



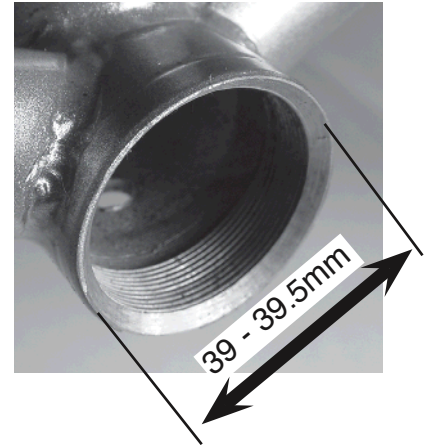

## Trouble-shooting

### Gear housing is slipping under load in low gear (models with cone rings)

- The bottom bracket wasn't chamfered correctly to the diameter given in our installation instructions (outer diameter of the conical part has to be between 39 and 39.5mm).
- The cone ring wasn't completely clean and dry.
- The nut on the left side wasn't tightened with the appropriate torque (140-160Nm / 100-115 lb ft).
- The cone ring isn't of the right material (knurled steel cone for aluminum bottom brackets, aluminum cone for steel bottom brackets).

-> We recommend completely removing the unit from the bottom bracket if it is spinning under load..

-> Check the chamfered part of the bottom bracket, clean it and roughen the surface of both the beveled region and cone ring.

-> Use the correct cone material.

-> Use our box spanner with a torque wrench for tightening.

Please note: newer **mountain-drives** just come with a conically shaped nut on the left. The material of this nut is of no importance in terms of friction, which is only required on the right side to counter the torque of the planetary gearing system.

### Nut comes loose after use (models with torque lever)

- The **mountain-drive** was installed with excessive play between the **mountain-drive** tube that goes into the bottom bracket and the inner diameter of the bottom bracket. Not enough shims were used.

- The nut on the left side wasn't tightened with the appropriate torque.

-> Either use shims to make up for small differences in diameter or chamfer the bottom bracket and use cone rings for perfect centering.

-> Tighten the unit with the appropriate torque (use the box spanner together with a torque wrench).

### Noise in high gear

New gears may run with some noise in high-gear mode when there is no load on the planets. This is normal due to manufacturing tolerances and does not affect efficiency. Gears normally run smoother after some break-in time. They also run smoother in low gear when there is load on the gears.

### Gear housing is loose, but nut can't be tightened nor screwed off

The bottom bracket shell may have a width of less than 67.5mm. The black nut of the **mountain-drive** came to the end of the thread before it clamped the housing. Please contact us to give you an advice.

## Skipping

Please check whether this is occurring in the front or the rear gearing system. If this occurs in direct-drive mode, mark the position of the crank in relation to the spider. If it is the **mountain-drive** that skips, the relative position of crank to spider will change. If, after the skipping has occurred, the position is still the same, the rear gearing system is at fault, due to a worn-out free-wheel mechanism, for example.

Always check the gear-shift buttons for correct position. After pushing the button and engaging the gear, the button should be approximately flush with the surface of the crankarm. It is important that you still can push the button a little, meaning there must be some play between gear shift button and axle bolt!

If the **mountain-drive** has been operated for a long time in an incorrect gear-shift button position, the clutch may be damaged. This would be due to overload of the clutch teeth caused by excessive pressure. If correcting the push-buttons doesn't help, the clutch and the two parts where the clutch engages, may need to be replaced.

BTW: The clutch parts never wear out when correctly adjusted.

Skipping can be caused by excessive play in the chainwheel along the axis of the spindle. This can be caused by mis-adjustment of the self-locking nut on the left end of the axle.

Please do not adjust this nut without understanding its function!!

**Very important:** If adjusting the nut on the left end of the axle, take care, that you do not preload the gearing system. There mustn't be any play in the direction of the spindle, but there mustn't be any preload on the system either!

To check the adjustment, proceed as follows:

- Unscrew the self locking nut on the axle 1/4 - 1/2 turns.
- Move the chainring in the direction of the spindle to feel the play.
- Slowly tighten the nut while moving the chainring at the same time.
- Feel the play decreasing.

Turn the crank several times, or ride a few hundred meters and check the play again. The balls sometimes need to be worked a little to find their final position within the ball race.

## Dismantling gear shift button and crankarm

Hold the button with some pliers and unscrew the tiny M3 Allen screw within the button with a 1.5-mm Allen wrench.

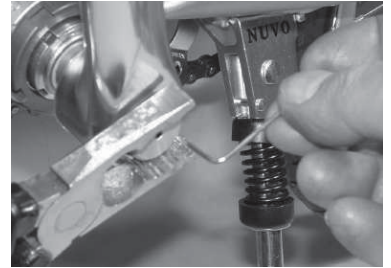

Unscrew the axle bolt with a 14mm box spanner. Please make sure that the washer underneath the axle bolt has been removed, too.

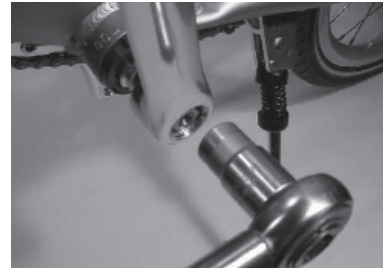

**Very important:** Always insert the small tube (part of our tool sets) between axle and puller to prevent the shifting shaft in the center of the axle from being destroyed by the puller.

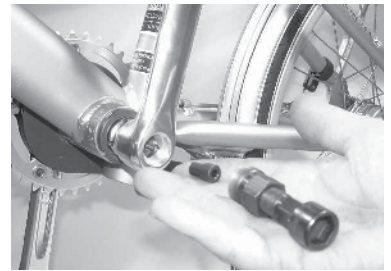

## Removing the *mountain-drive* from the frame. Dismantling.

Unscrew the torque lever's M6 nut.

Remove the black nut on the left side using a box spanner (from our tool set "Installation + Maintenance").

### **Never remove the gray nut on the axle!**

Please note: *mountain-drives* always comes with a left hand thread!

Position a crank in a vise and hold the *mountain-drive* as shown on the right. Unscrew the right gear-shift button and axle bolt, and remove the right crank according to the left one.

Remove the three Torx screws and one slot screw (4 x hex screws and 4 black aluminum nuts on a *mountain-drive* with steel spider) and take off the spider.

Lift the steel cover and check to see whether the large O-ring remained on top of the housing or if it is still within the cover.

Turn the unit around and unscrew the self-locking nut (right hand thread).

**Very important:** After having removed the left bearing, count the exact number of 0.1mm spacers between bearing and circlip. Check to see whether any spacers are still sticking to the bearing! When reassembling, you must use exactly the same number of spacers at this position!

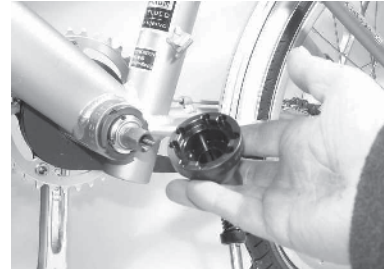
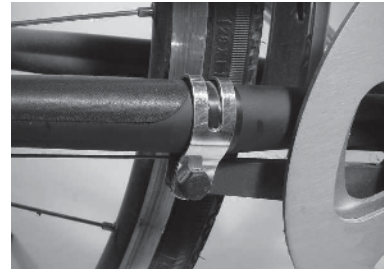

Carefully lift the gear housing. If it sticks and can't be removed without force, hold down the circlip in the center.

Remove the circlip.

Put the axle on top of the crank in the following way:  
The dot marking on the upper end should be facing you.

Hold two fingers as shown in the photo and carefully lift the spacer tube while rotating it slightly. Please note that two small springs are held by this spacer tube. The hole for this springs is oriented in the same direction as the dot marking on the axle.

The springs now will have jumped out and you should also set aside two balls (diameter 4.00 mm), which may be still in the hole of the axle.  
Take off the right cartridge bearings.

**Important:** Check again to see whether there are 0.1mm spacers between the right cartridge bearing and the ball bearing's cone ring.

Remove the bearing cone.

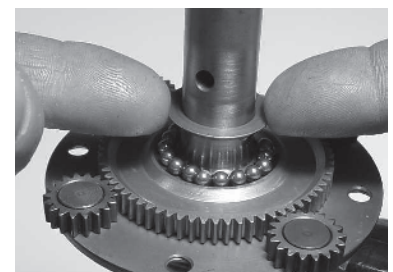
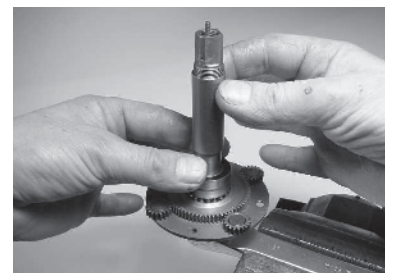
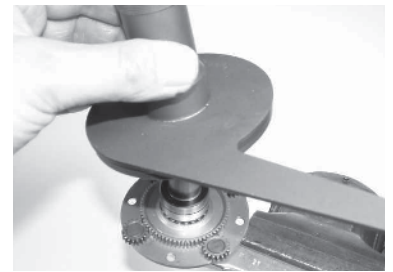



Take a clean piece of fabric and take the last pieces apart.  
Important: **mountain-drive** uses balls of metric size 4.00 mm and not the similar inch size 5/32"!

Screw on a gear-shift button on the left side and push the shifting shaft towards the right side. With thin pliers, remove the tiny circlip near the right end of the shifting shaft.  
Note: Never use a circlip twice!

After removing the shifting shaft, you will find two spring-steel pieces in the cross-hole of the axle.

Check for two long springs (approximately 14 mm long) and two shorter ones (approximately 5.5 mm long).

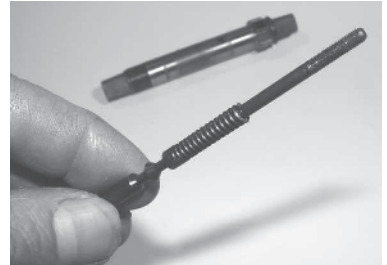
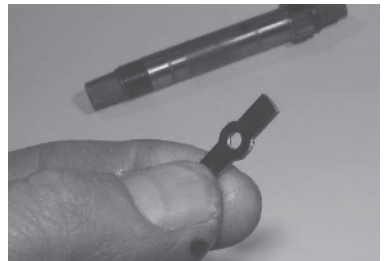
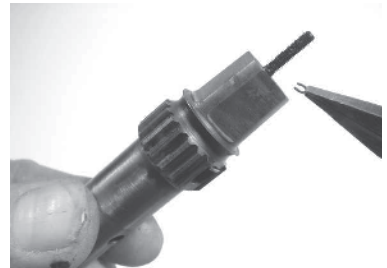
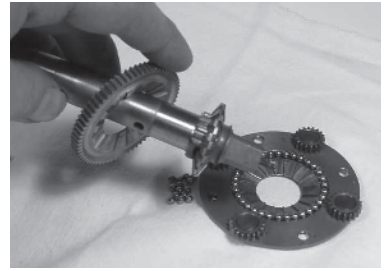

## Assembling

Put one of the longer springs on the shifting shaft.

Insert the two spring-steel pieces into the axle's cross-hole.

Again, screw on a gear-shift button to the left side of the shifting shaft. Push the shifting shaft to the right side and put on the second spring and the circlip 1.5 mm. Check to make sure the circlip has snapped on correctly.

The next step is critical to proper functioning. The teeth of the clutch must be oriented as seen in the picture to the right (as viewed from the right side). In other words, the leading edge of the teeth should match with radial lines extending from the center of the axle.

This is the wrong orientation!

There is a groove on the inner diameter of the clutch. Try to snap the clutch on one side of the spring-steel pieces. Then push the clutch to the right side and push with the screwed on button from the right side to the left, until the clutch has audibly engaged.

Please check: With newer cranks (with right-angled cross hole in the axle), the travel of the clutch is 5mm. With older cranks (oval cross hole in the axle) the clutch travel is about 3.5mm.

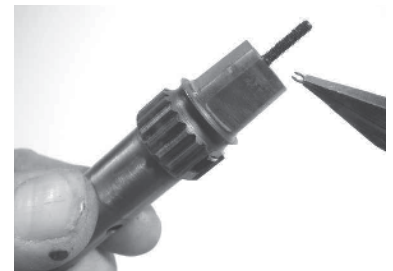
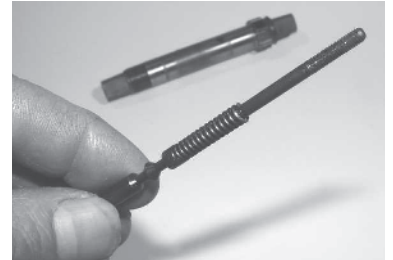

This is the right way! The leading edges of the teeth match with radial lines from the centre of the axle.

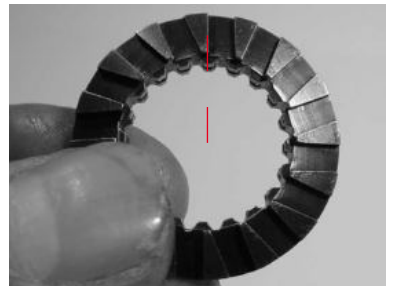

Wrong way! Do not mount it this way!!

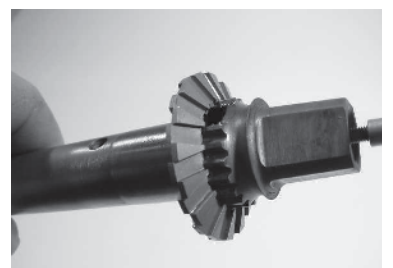
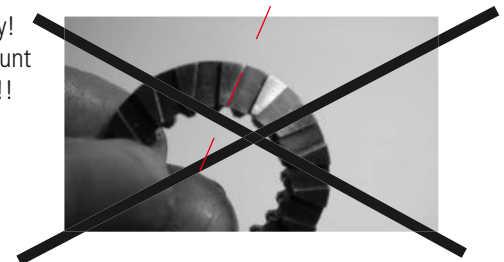

Now fill in balls to the race of the planet carrier and finally take two balls out of the race. Put two portions of grease on the planet carrier.

Hold the planet carrier as shown on the right. Slightly grease the ball race.

Put on the sunwheel.  
Hold the planet carrier and the sunwheel against each other and turn the whole package over.

Now hold the sunwheel with two fingers and press the axle slightly upwards. This allows you to fill balls into the outer ball race. Remove one ball.

Press the whole package together again and turn it over.  
Put it onto the crank in your vice again. Fill the left ball race with balls and remove one ball.  
Slip on the bearing cone and the same number of 0.1mm spacers as you had removed before. Add some MoS<sub>2</sub>-grease to the balls.  
Finally slip on the cartridge bearings (add some grease to the bearings, if they are unsealed ones).

Press some grease into the cross hole of the axle and insert 2 balls and the two short springs from each side.  
Carefully slip the spacer tube with its larger diameter ahead on the axle.

Press the springs towards the axle and slip on the tube.

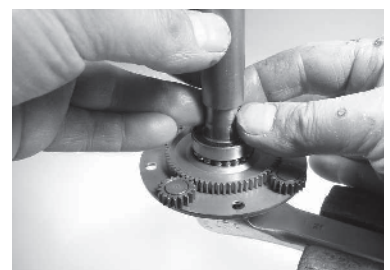
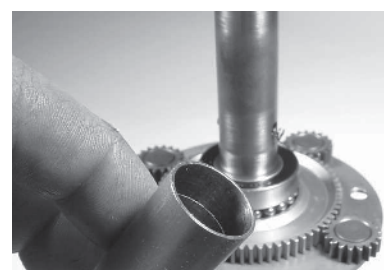
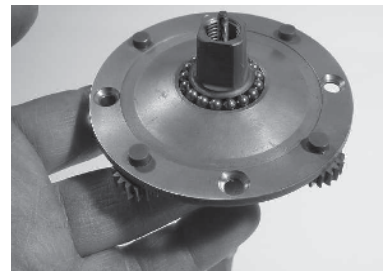
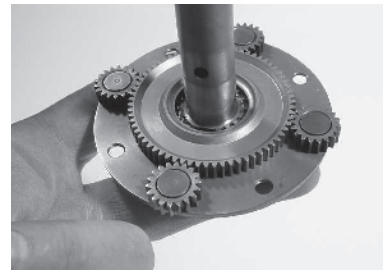
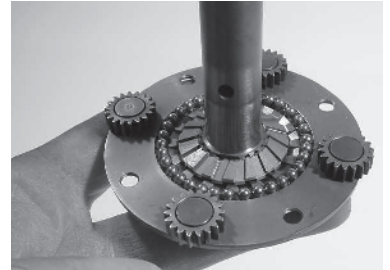
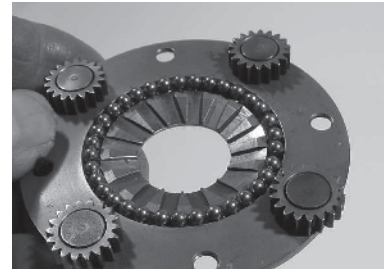

Mount the circlip.



Slip on the housing.

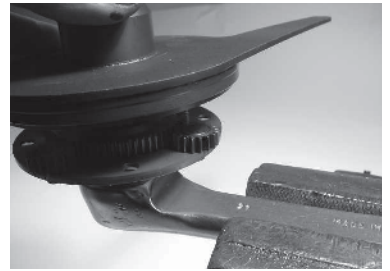

Add exactly the same number of 0.1mm spacers as have been removed before.

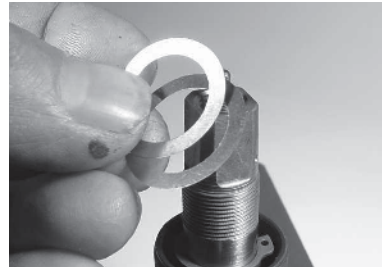

The left bearing must be in contact with the parts lying below it on its inner and outer diameter. If you press with a tube or with a 17mm wrench on top of the inner ring of the bearing, you should be able to just turn the outer ring without too much friction between outer bearing ring and gear housing tube.



This step is very important, as too few spacers may leave the left bearing misadjusted, which can cause excessive load on the left bearing in the direction of the spindle. If needed, add one 0.1mm spacer between the circlip and left cartridge bearing.

Mount the self locking nut.

Tighten it to the point where the left cartridge bearing can't be moved vertically any longer. Then unscrew the nut 1/4 revolution.

Size of the nut: M17x1



Turn over the unit and mount the O-ring. The O-ring and its seat must be clean and dry. If not, the O-ring probably won't remain in its position.

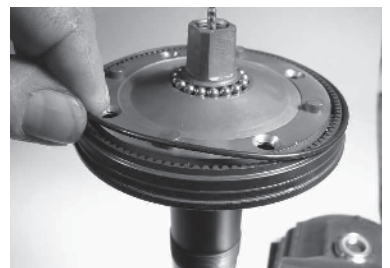

Carefully mount the steel cover.

After having done this, press the cover down and try to rotate the gear housing. If you can rotate it, the O-ring is well positioned.

If it doesn't rotate freely, the O-ring is probably out of its seat.

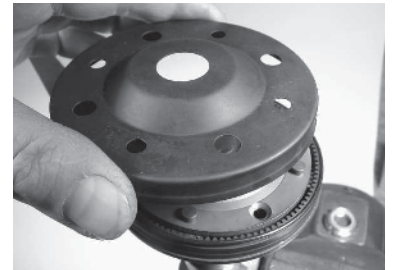

Mount the spider and fit it with 3 Torx screws.

Shift into low gear by pressing the shifting shaft down .

The gear housing must still rotate freely. If it doesn't, the O-ring is no longer in its correct position.

Now adjust the gearing play. The easiest way is to move the spider up and down and to slowly tighten the self-locking nut at the same time.

The adjustment is perfect , when there is no longer any play on the spider but also no load on the bearings due to excessive tightening.

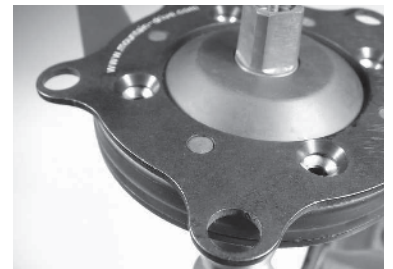

Now add some grease through the lubrication hole and close it with the slot screw.



Mount the right crank and gear-shift button.



Check the gearing play again after riding a few hundred meters.



## Assembly Instructions

### 1. Bottom bracket dimensions

Please check first for correct dimensions of the b.b. shell: standard **mountain-drive** fits bottom brackets with width from 67.5 up to 73mm. If the b.b. shell is shorter, please ask for washers or, in case of a longer shell, use the 10mm longer version, that is available.

Diameter: the unit is designed for BSA (1.37"x24) threads, but you can compensate for small differences in diameter with the shims that are included in the basic package (**mountain-drive** with torque lever only).

To handle larger differences in diameter, ask for our special adapter (see fig. 2). Please specify exact inner diameter of bottom bracket tube.

### 2. Three installation options

Please note: **mountain-drive** uses left-handed threading, the **speed- and high-speed-drive** uses right-handed threading. Important: For installation, unscrew only the black nut, never the gray one!!

#### 2.1 Standard installation (**mountain-drive** with torque lever)

- Insert the **mountain-drive** unit in the empty bottom bracket shell.
- Use shims (1/10mm thickness) to make up for small difference in diameter.
- Important: You must be able to easily slide the **mountain-drive** - unit into the bottom bracket tube. Never force it, and never use a hammer!!

#### 2.2 Adapter installation

If there is a substantial difference in diameter, use a pair of adapters. Do not attempt to combine this option with the cone installation.

#### 2.3 Cone installation

If you want to fit the **mountain-drive** unit without the anti-twisting bracket, you must prepare the bottom bracket tube as shown in Fig. 3. It is very important that the diameter of the conical part is 39 - 39,5mm. To tighten the lockring, use the special box spanner and combine it with a torque wrench. Tighten this down very hard! Torque: 100-115 lb/ft (140-160Nm). Do not use the cone installation with thin aluminum bottom bracket shells. The conical rings exert considerable force that could damage the shell.

Use a steel cone on the right side for aluminum b.b. shells and an aluminum cone for steel bottom bracket shells.

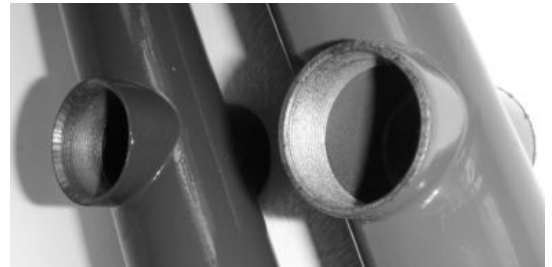

Fig. 1: Standard bottom bracket shells with and without chamfered edge.



Fig. 2: Adapters for larger diameter of the b.b. shell. Please specify inner diameter when ordering.



Fig. 3: Correct diameter of chamfering is most important for perfect function!

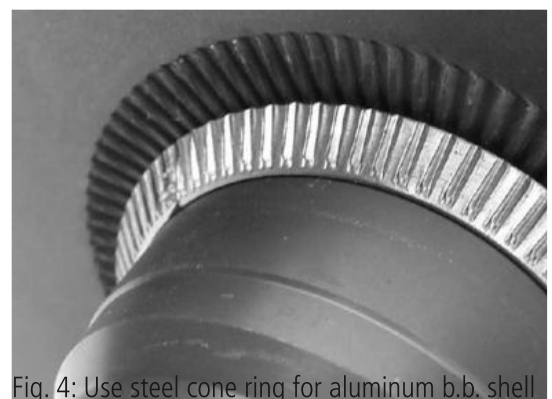

Fig. 4: Use steel cone ring for aluminum b.b. shell and aluminum cone ring for steel shell.

### 3. Crank Assembly

The right side crank is usually preassembled by the manufacturer. For tightening the left crankarm, please use a torque wrench and tighten with a torque of 50-55Nm (35-40 lbft).

Very important: When disassembling a crankarm, always use the small tube (part of the tool sets) in combination with a standard puller to avoid damaging the thin shifting shaft!

### 4. Chainring

If possible, always fit the chainring to the left side of the spider. Put washers between the spider and chainring in order to achieve a chainline that is 2mm narrower.

Please note: all chainrings provided by the maker can be mounted to the left side of the spider without disassembling the whole drive! Chainrings smaller than 40t. come with a turned out inner diameter.

### 5. Gearshift button

- Screw in the gearshift button about two full turns.
- Push the button.
- Important: Turn the crank slightly, until the switch engages.
- Turn the gearshift button until it is flush with the crank. It is very important that there is some play between the axle nut and the gearshift button.
- Adjust the button and tighten Allen set-screw very firmly with the 1.5mm hex bit of the tool sets.

### 6. Some Maintenance Information

- Lubrication: Periodically (once or twice a year) remove the screw on the front and insert about 1/3 of the content of the syringe with special lube. Standard bicycle oil may do the job as well, but it won't last as long time as the special grease due to the only little pressure of the sealing.

- Bearing play: After several hundred miles of use, check for bearing play. The chainring must not have any play along the spindle axis. If there is any play, slightly tighten the self-locking nut on the left end of the axle. Never tighten the nut too firmly. Some play between the cranks and chainring in the direction of crank rotation is normal and necessary for proper engagement of the gears after switching.



Fig. 5: Use the box wrench in combination with a torque wrench.



Fig. 6: Hold the gear shift button with the small wrench and tighten it with the 1.5mm hex bit.



Fig. 7: Lubrication. insert about 1/3 of the syringe once or twice a year.



Fig. 8: Adjusting of gearing play. No preload!

## Technical data

### Tightening torques

Black nut on the left side:

- version with torque lever: 80 - 100 Nm (55 - 70 lbfft)
- version with cone rings: 140 - 160 Nm (100 - 115 lbft)

- Grey nut for adjusting gearing play 0 Nm (0 lbft)  
No preload!!

- Axle bolt 50 - 55 Nm (35 - 38 lbft)

- Gear shift button 110 cNm (0.8 lbft)

- Chainring screws 12 - 14 Nm (8.5 - 10 lbft)

- Spider 12 Nm (8.5 lbft)

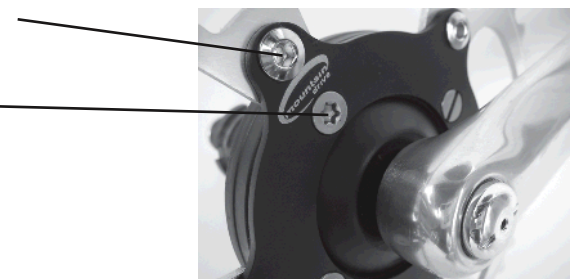
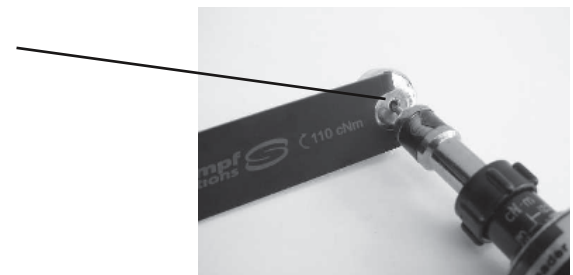
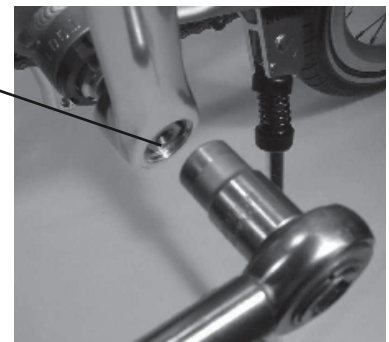
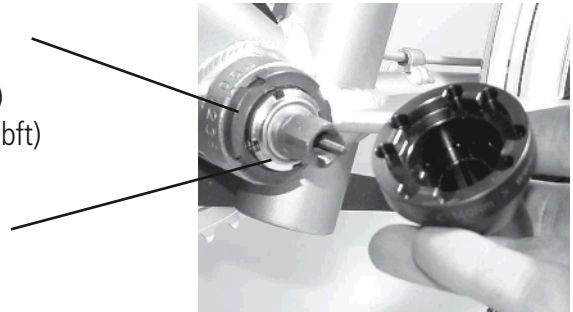



N-1

## Check list for ordering

- **mountain - drive** with torque lever or cone rings ?
- if fitting with cone rings: for aluminum or steel bottom bracket shell ?
- tooth count of the chainring ?
- with trouser guard or not ?
- b.b. shell of standard BSA size (inner diameter 33.6 - 34mm, width 67.5 to 73mm) ?
- **mountain - drive** with reinforced steel spider for tandem, double chainring, rickshaw or the like ?
- standard crankarms 170mm ?
- with easy - shift kick plates (for 170mm cranks available only) ?
- tool set ?
- do you have a 45°milling cutter for chamfering the b.b. shell if mounting with cone rings ?
- if not: buying or renting (we have a rental service in most countries) ?
- shipping: by standard economy or priority post service or with private carrier like FedEx or UPS (much more expensive) ?



schlumpf innovations gmbh  
Dorfstr. 10  
CH - 7324 Vilters/Switzerland  
Tel: +41 (0)81 723 80 09  
Fax: +41 (0)81 723 83 64  
email: info@schlumpf.ch  
[www.schlumpf.ch](http://www.schlumpf.ch)  
[www.mountain-drive.com](http://www.mountain-drive.com)  
Geschäftsführer/CEO:  
Florian Schlumpf Masch.Ing.HTL